

User Manual

PF 1 6K/10K Online UPS

Uninterruptible Power Supply System

Version: 1.2



Please comply with all warnings and operating instructions in this manual strictly. Save this manual properly and read carefully the following instructions before installing the unit. Do not operate this unit before reading through all safety information and operating instructions carefully.

Table of Contents

1. SAFETY AND EMC INSTRUCTIONS	1
1-1. TRANSPORTATION AND STORAGE	1
1-2. PREPARATION	1
1-3. INSTALLATION	1
1-4.  CONNECTION WARNINGS	2
1-5. OPERATION	3
1-6. STANDARDS	3
2. INSTALLATION AND OPERATION	4
2-1. UNPACKING AND INSPECTION	4
2-2. REAR PANEL VIEW	4
2-3. SINGLE UPS INSTALLATION	5
2-4. UPS INSTALLATION FOR PARALLEL SYSTEM	7
2-5. SOFTWARE INSTALLATION	8
3. OPERATIONS	9
3-1. BUTTON OPERATION	9
3-2. LED INDICATORS AND LCD PANEL	9
3-3. AUDIBLE ALARM	11
3-4. SINGLE UPS OPERATION	11
3-5. PARALLEL OPERATION	15
3-6. ABBREVIATION MEANING IN LCD DISPLAY	16
3-7. LCD SETTING	17
3-8. OPERATING MODE/STATUS DESCRIPTION	21
3-9. FAULT CODE	23
3-10. WARNING INDICATOR	24
3-11. WARNING CODE	24
4. TROUBLE SHOOTING	25
5. STORAGE AND MAINTENANCE	26
5-1. STORAGE	26
5-2. MAINTENANCE	26
6. SPECIFICATIONS	27

1. Safety and EMC instructions

Please read carefully the following user manual and the safety instructions before installing the unit or using the unit!

1-1. Transportation and Storage



Please transport the UPS system only in the original package to protect against shock and impact.



The UPS must be stored in the room where it is ventilated and dry.

1-2. Preparation



Condensation may occur if the UPS system is moved directly from cold to warm environment. The UPS system must be absolutely dry before being installed. Please allow at least two hours for the UPS system to acclimate the environment.



Do not install the UPS system near water or in moist environments.



Do not install the UPS system where it would be exposed to direct sunlight or nearby heater.



Do not block ventilation holes in the UPS housing.

1-3. Installation



Do not connect appliances or devices which would overload the UPS (e.g. big motor-type equipment)) to the UPS output sockets or terminal.



Place cables in such a way that no one can step on or trip over them.



Do not block air vents in the housing of UPS. The UPS must be installed in a location with good ventilation. Ensure enough space on each side for ventilation.



UPS has provided earthed terminal, in the final installed system configuration, equipotential earth bonding to the external UPS battery cabinets.



The UPS can be installed only by qualified maintenance personnel.



An appropriate disconnect device as short-circuit backup protection should be provided in the building wiring installation.



An integral single emergency switching device which prevents further supply to the load by the UPS in any mode of operation should be provided in the building wiring installation.



Connect the earth before connecting to the building wiring terminal.



Installation and Wiring must be performed in accordance with the local electrical laws and regulations.

1-4. Connection Warnings

- There is no standard backfeed protection inside of the UPS. Please isolate the UPS before working according to Diagram 1. The isolation device must be able to carry the UPS input current.

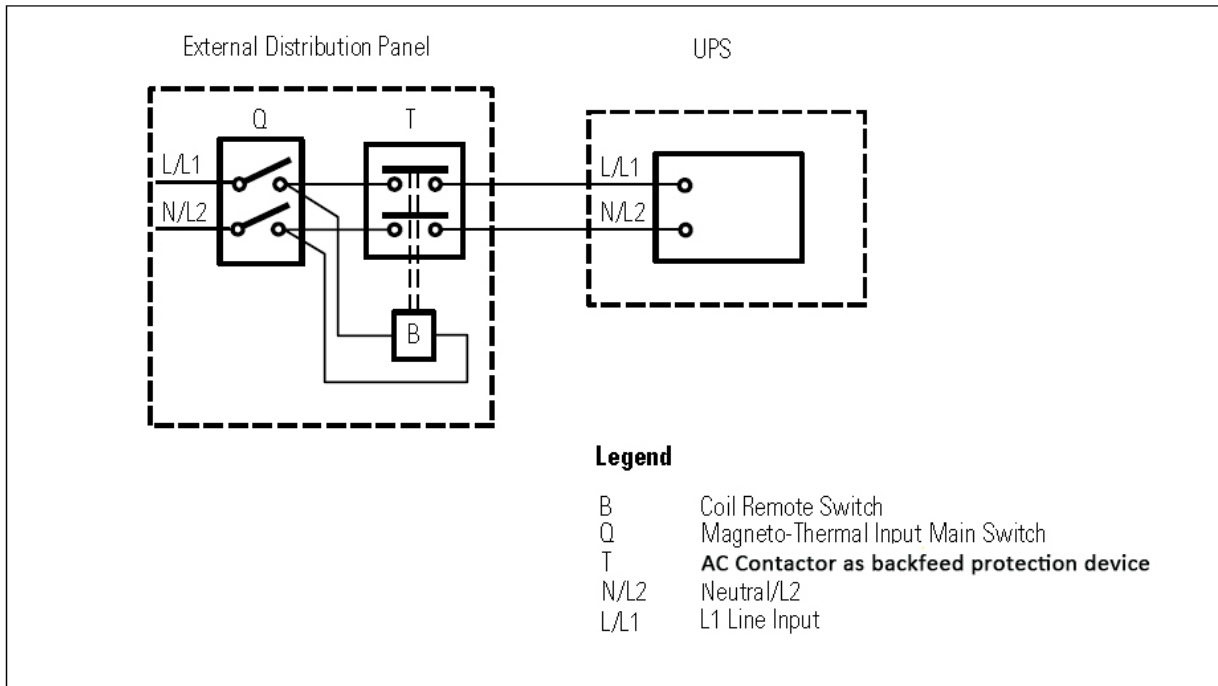

Diagram 1: External backfeed protection wiring

- This UPS should be connected with **TN** earthing system.
- The power supply for this unit must be single-phase rated in accordance with the equipment nameplate. It also must be suitably grounded.
- Use of this equipment in life support applications where failure of this equipment can reasonably be expected to cause the failure of the life support equipment or to significantly affect its safety or effectiveness is not recommended. Do not use this equipment in the presence of a flammable anesthetic mixture with air, oxygen or nitrous oxide.
- Connect your UPS power module's grounding terminal to a grounding electrode conductor.
- The UPS is connected to a DC energy source (battery). The output terminals may be live when the UPS is not connected to an AC supply.

Before working on this circuit

- Isolate Uninterruptible Power System (UPS)
- Then check for Hazardous Voltage between all terminals including the protective earth.



Risk of Voltage Backfeed

1-5. Operation



Do not disconnect the earth conductor cable on the UPS or the building wiring terminals in any time since this would cancel the protective earth of the UPS system and of all connected loads.



The UPS system features its own, internal current source (batteries). The UPS output sockets or output terminal blocks may be electrically live even if the UPS system is not connected to the building wiring outlet.



In order to fully disconnect the UPS system, first press the "OFF" button and then disconnect the mains.



Ensure that no liquid or other foreign objects can enter into the UPS system.



The UPS can be operated by any individuals with no previous experience.

1-6. Standards

* Safety	
IEC/EN 62040-1	
* EMI	
Conducted Emission.....:IEC/EN 62040-2	Category C3
Radiated Emission.....:IEC/EN 62040-2	Category C3
*EMS	
ESD.....:IEC/EN 61000-4-2	Level 4
RS..... :IEC/EN 61000-4-3	Level 3
EFT..... :IEC/EN 61000-4-4	Level 4
SURGE..... :IEC/EN 61000-4-5	Level 4
CS..... :IEC/EN 61000-4-6	Level 3
Power-frequency Magnetic field..... :IEC/EN 61000-4-8	Level 4
Low Frequency Signals.....:IEC/EN 61000-2-2	
Warning: This is a product for commercial and industrial application in the second environment-installation restrictions or additional measures may be needed to prevent disturbances.	

2. Installation and Operation

There are two different types of online UPS: standard and long-run models. Please refer to the following model table.

Model	Type	Model	Type
6K	standard model	6KL	Long-run model
10K		10KL	

Parallel function is also available for these two types and related installation and operation of Parallel function will be described in detail in the following content.

2-1. Unpacking and Inspection

Unpack the package and check the package contents. The shipping package contains:

- One UPS
- One user manual
- One monitoring software CD
- One RS-232 cable (option)
- One USB cable
- One parallel cable (only available for parallel model)
- One share current cable (only available for parallel model)
- One battery cable (option)

NOTE: Before installation, please inspect the unit. Be sure that nothing inside the package is damaged during transportation. Do not turn on the unit and notify the carrier and dealer immediately if there is any damage or lacking of some parts. Please keep the original package in a safe place for future use.

2-2. Rear Panel View

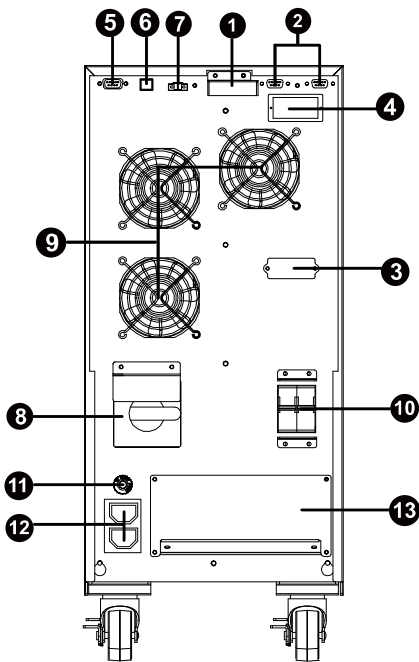

**Diagram 1: 6K/10K
Rear Panel**

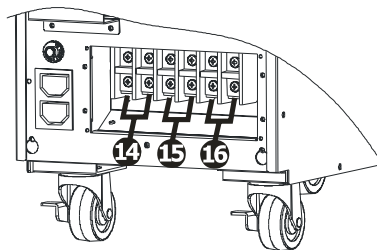

**Diagram 2: 6K/10K
Input/output Terminal**

- 1) Share current port (only available for parallel model)
- 2) Parallel port (only available for parallel model)
- 3) External battery connector
- 4) Intelligent slot
- 5) RS-232 communication port
- 6) USB communication port
- 7) Emergency power off function connector (EPO connector)
- 8) Maintenance bypass switch
- 9) Cooling fans
- 10) Input circuit breaker
- 11) Output circuit breaker for receptacles
- 12) Output receptacles: connect to mission-critical loads
- 13) Input/output terminal
- 14) output terminal: connect to mission-critical loads
- 15) Programmable output terminal
- 16) Utility input

This UPS is without programmable output function.

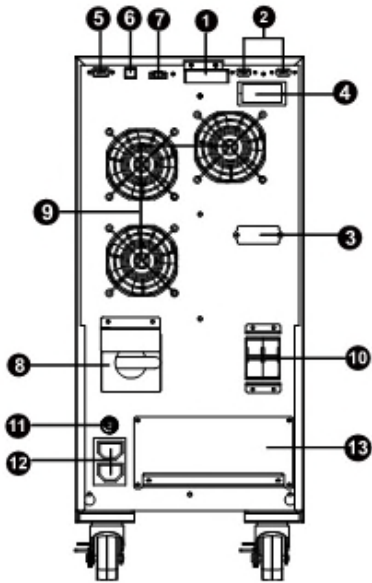

**Diagram 1: 6K/10K
Rear Panel**

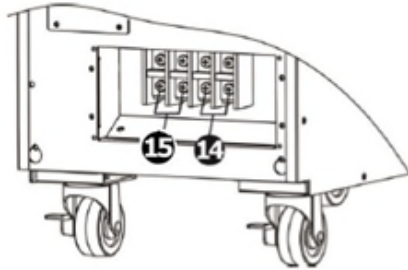

**Diagram 2: 6K/10K
Input/output Terminal**

- 1) Share current port (only available for parallel model)
- 2) Parallel port (only available for parallel model)
- 3) External battery connector
- 4) Intelligent slot
- 5) RS-232 communication port
- 6) USB communication port
- 7) Emergency power off function connector (EPO connector)
- 8) Maintenance bypass switch
- 9) Cooling fans
- 10) Input circuit breaker
- 11) Output circuit breaker for receptacles
- 12) Output receptacles: connect to mission-critical loads
- 13) Input/output terminal
- 14) Input terminal
- 15) output terminal: connect to mission-critical loads

2-3. Single UPS Installation

Installation and wiring must be performed in accordance with the local electric laws/regulations and execute the following instructions by professional personnel.

- 1) Make sure the mains wire and breakers in the building are enough for the rated capacity of UPS to avoid the hazards of electric shock or fire.

NOTE: Do not use the wall receptacle as the input power source for the UPS, as its rated current is less than the UPS's maximum input current. Otherwise the receptacle may be burned and destroyed.

- 2) Switch off the mains switch in the building before installation.
- 3) Turn off all the connected devices before connecting to the UPS.
- 4) Prepare wires based on the following table:

Model	Wiring spec (AWG)			
	Input	Output	Battery	Ground
6K	10	10	/	10
6KL	10	10		10
10K	8	8	/	8
10KL	8	8		8

NOTE 1: The cable for 6K/6KL should be able to withstand over 40A current. It is recommended to use 10AWG or thicker wire for safety and efficiency.

NOTE 2: The cable for 10K/10KL should be able to withstand over 63A current. It is recommended to use 8AWG or thicker wire for safety and efficiency.

NOTE 3: The selections for color of wires should be followed by the local electrical laws and regulations.

- 5) Remove the terminal block cover on the rear panel of UPS. Then connect the wires according to the

following terminal block diagrams: (Connect the earth wire first when making wire connection. Disconnect the earth wire last when making wire disconnection!)

UPS with programmable output programmable output function

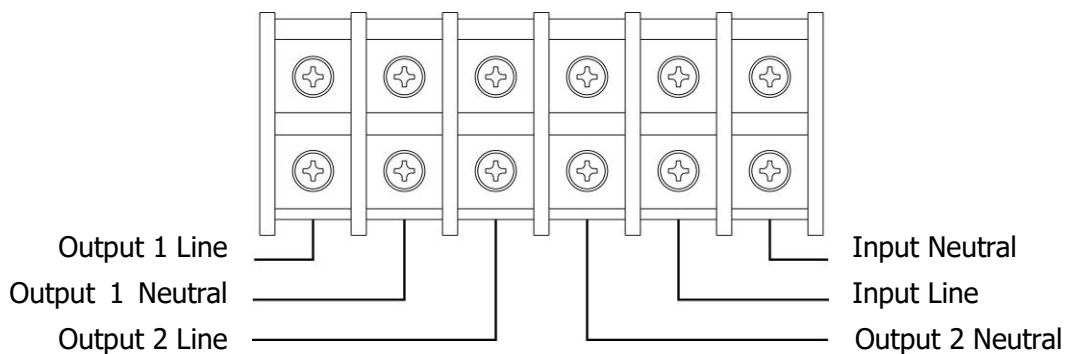

Terminal Block wiring diagram

NOTE 1: Make sure that the wires are connected tightly with the terminals.

NOTE 2: Please install the output breaker between the output terminal and the load, and the breaker should be qualified with leakage current protective function if necessary.

UPS without programmable output programmable output function

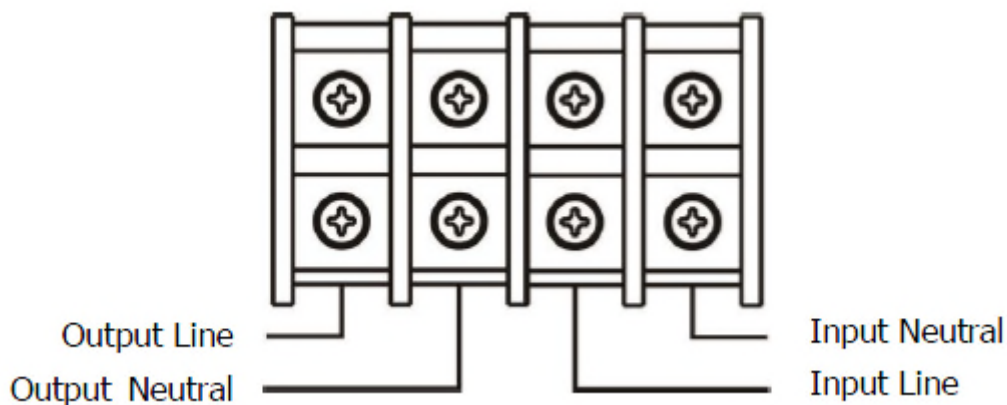

Terminal Block wiring diagram

NOTE 1: Make sure that the wires are connected tightly with the terminals.

NOTE 2: Please install the output breaker between the output terminal and the load, and the breaker should be qualified with leakage current protective function if necessary.

6) Put the terminal block cover back to the rear panel of the UPS.



Warning: (Only for standard model)

- Make sure the UPS is not turned on before installation. The UPS should not be turned on during wiring connection.
- Do not try to modify the standard model to the long-run model. Particularly, do not try to connect the standard internal battery to the external battery. The battery type and voltage may be different. If you connect them together, it maybe causes the hazard of electric shock or fire!



Warning: (Only for long-run model)

- Make sure a DC breaker or other protection device between UPS and external battery pack is installed. If not, please install it carefully. Switch off the battery breaker before installation.



Warning:

- For standard battery pack, there is one DC breaker to disconnect the battery pack and the UPS. But for other external battery pack, make sure a DC breaker or other protection device between UPS and external battery pack is installed. If not, please install it carefully. Switch off the battery breaker before installation.

NOTE: Set the battery pack breaker in "OFF" position and then install the battery pack.

- Pay highly attention to the rated battery voltage marked on the rear panel. If you want to change the numbers of the battery pack, please make sure you modify the setting simultaneously. The connection with wrong battery voltage may cause permanent damage of the UPS. Make sure the voltage of the battery pack is correct.
- Pay highly attention to the polarity marking on external battery terminal block, and make sure the correct battery polarity is connected. Wrong connection may cause permanent damage of the UPS.
- Make sure the protective earth ground wiring is correct. The wire current spec, color, position, connection and conductance reliability should be checked carefully.
- Make sure the utility input & output wiring is correct. The wire current spec, color, position, connection and conductance reliability should be checked carefully. Make sure the L/N site is correct, not reverse and short-circuited.

2-4. UPS Installation for Parallel System

If the UPS is only available for single operation, you may skip this section to the next.

- 1) Install and wires the UPSs according to the section 2-3.
- 2) Connect the output wires of each UPS to an output breaker.
- 3) Connect all output breakers to a major output breaker. Then this major output breaker will directly connect to the loads.
- 4) Each UPS is connected to an independent battery pack.
- 5) Remove the cover of parallel share current cable port on the UPS, connect each UPS one by one with the parallel cable and share current cable, and then screw the cover back again.

NOTE: The parallel system can not use one battery pack. Otherwise, it will cause system permanent failure.

- 6) Refer to the following wiring diagram:

UPS with programmable output programmable output function

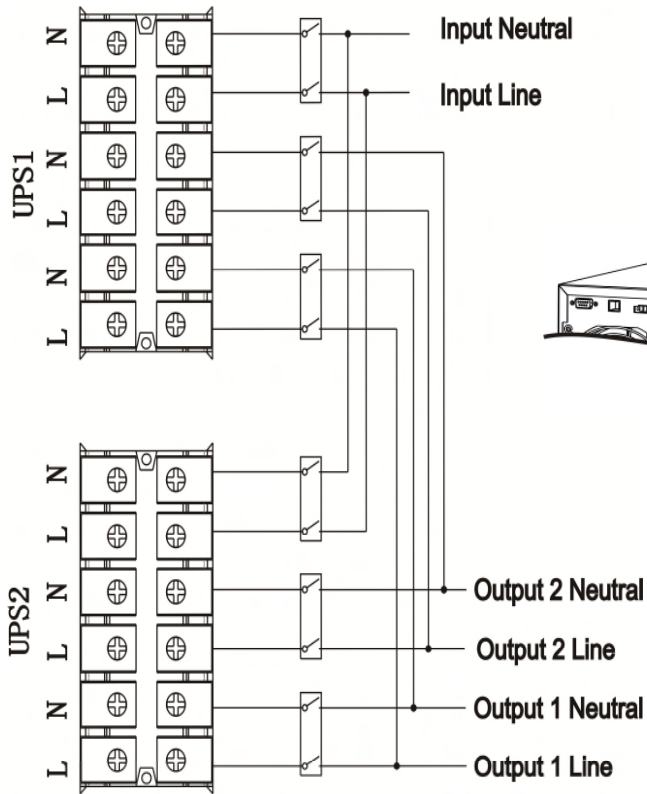

Diagram 1: Power cable connection

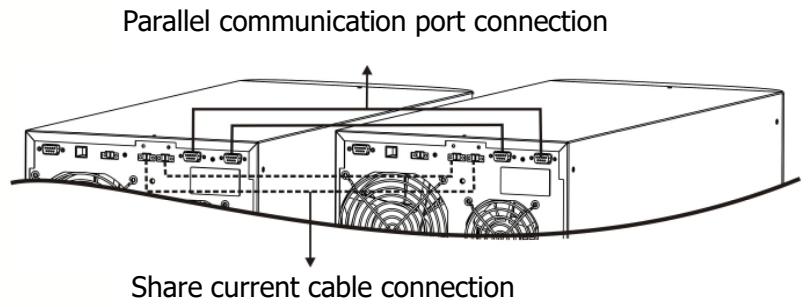

Diagram 2: Communication cable connection

UPS without programmable output programmable output function

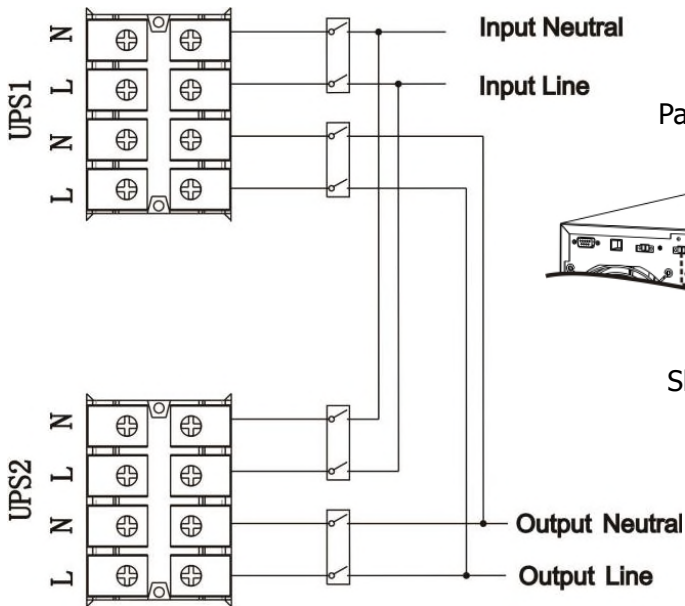

Diagram 3: Power cable connection

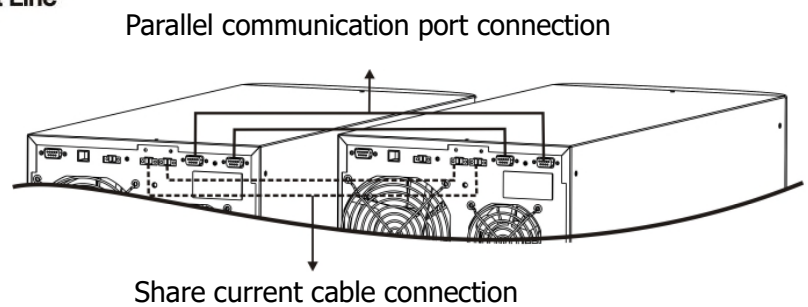

Diagram 4: Communication cable connection

Wiring diagram of parallel system

2-5. Software Installation

For optimal computer system protection, install UPS monitoring software to fully configure UPS shutdown.

3. Operations

3-1. Button Operation

Button	Function
ON/Enter Button	<ul style="list-style-type: none"> ➤ Turn on the UPS: Press and hold the button more than 0.5s to turn on the UPS. ➤ Enter Key: Press this button to confirm the selection in setting menu.
OFF/ESC Button	<ul style="list-style-type: none"> ➤ Turn off the UPS: Press and hold the button more than 0.5s to turn off the UPS. ➤ Esc key: Press this button to return to last menu in setting menu.
Test/Up Button	<ul style="list-style-type: none"> ➤ Battery test: Press and hold the button more than 0.5s to test the battery while in AC mode, or CVCF mode. ➤ UP key: Press this button to display next selection in setting menu.
Mute/Down Button	<ul style="list-style-type: none"> ➤ Mute the alarm: Press and hold the button more than 0.5s to mute the buzzer. Please refer to section 3-4-9 for details. ➤ Down key: Press this button to display previous selection in setting menu.
Test/Up + Mute/Down Button	<ul style="list-style-type: none"> ➤ Press and hold the two buttons simultaneous more than 1s to enter/escape the setting menu.

* CVCF mode means converter mode.

3-2. LED Indicators and LCD Panel

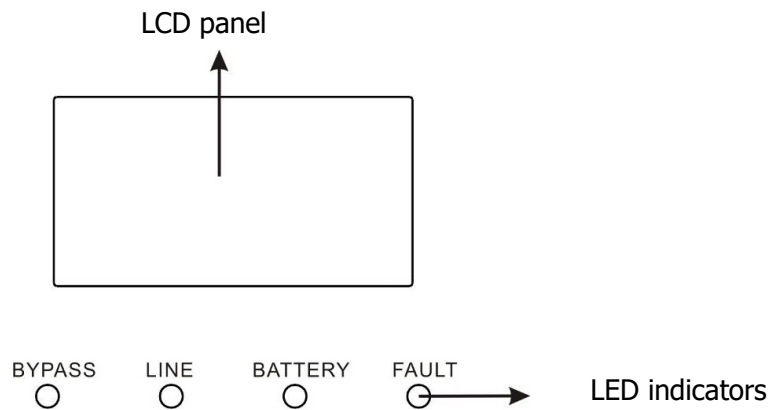

There are 4 LEDs on front panel to show the UPS working status:



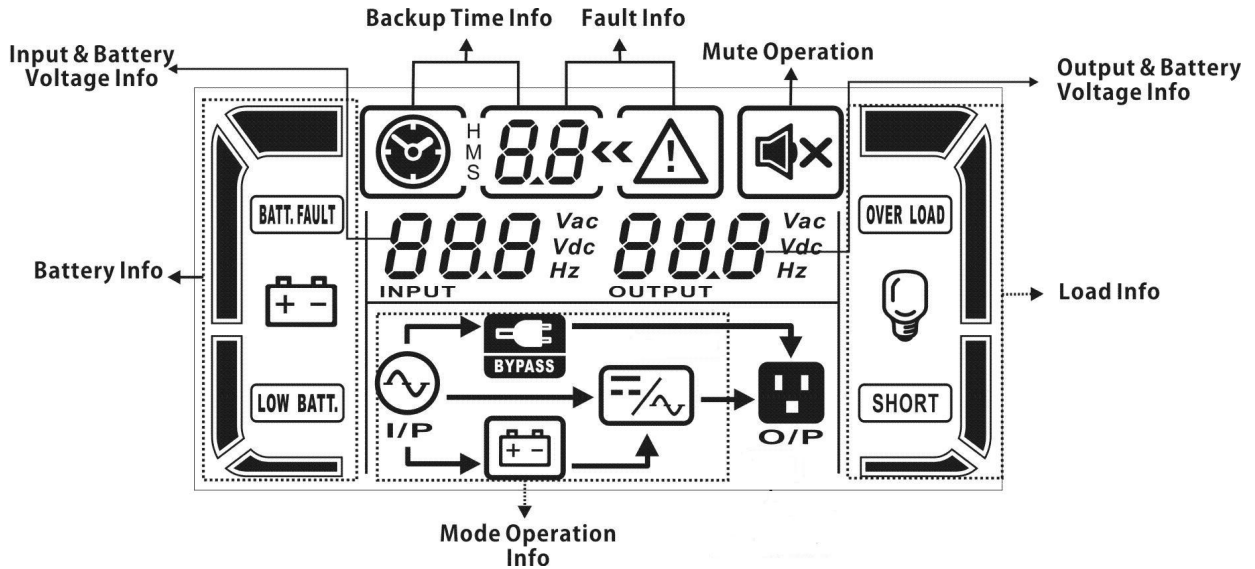

Mode \ LED	Bypass	Line	Battery	Fault
UPS Startup	●	●	●	●
No Output mode	○	○	○	○
Bypass mode	●	○	○	○
AC mode	○	●	○	○
Battery mode	○	○	●	○
CVCF mode	○	●	○	○
Battery Test	●	●	●	○
ECO mode	●	●	○	○
Fault	○	○	○	●

Note: ● means LED is lighting, and ○ means LED is faded.

LCD Panel:



Display	Function
Backup time information	
	Indicates battery discharge time in numbers. H: hours, M: minutes, S: seconds
Fault information	
	Indicates that the warning and fault occurs.
	Indicates the fault codes, and the codes are listed in details in section 3-9.
Mute operation	
	Indicates that the UPS alarm is disabled.
Output & Battery voltage information	
	Indicates the output voltage, frequency or battery voltage. Vac: output voltage, Vdc: battery voltage, Hz: frequency
Load information	
	Indicates the load level by 0-25%, 26-50%, 51-75%, and 76-100%.
	Indicates overload.
	Indicates the load or the output is short.
Programmable output information*	
	Indicates that the programmable outputs are working.
Mode operation information	
	Indicates the UPS connects to the mains.
	Indicates the battery is working.
	Indicates the bypass circuit is working.
	Indicates the ECO mode is enabled.
	Indicates the Inverter circuit is working.

	Indicates the output is working.
Battery information	
	Indicates the Battery capacity by 0-25%, 26-50%, 51-75%, and 76-100%.
	Indicates the battery is not connected.
	Indicates low battery level and low battery voltage.
Input & Battery voltage information	
	Indicates the input voltage or frequency or battery voltage. Vac: Input voltage, Vdc: battery voltage, Hz: input frequency

*Programmable output information: This function is only available for the UPS equipped programmable output. This icon is only shown on the LCD screen for the UPS with programmable output function.

3-3. Audible Alarm

Description	Buzzer status	Muted
UPS status		
Bypass mode	Beeping once every 2 minutes	Yes
Battery mode	Beeping once every 4 seconds	
Fault mode	Beeping continuously	
Warning		
Overload	Beeping twice every second	Yes
Others	Beeping once every second	
Fault		
All	Beeping continuously	Yes

3-4. Single UPS Operation

3-4-1. Turn on the UPS with utility power supply (in AC mode)

- 1) After power supply is connected correctly, set the breaker of the battery pack at "ON" position (the step only available for long-run model). Then set the input breaker at "ON" position. At this time the fan is running and the UPS enter to power on mode for initialization, several seconds later, UPS operates in Bypass mode and supplies power to the loads via the bypass.

NOTE: When UPS is in Bypass mode, the output voltage will directly power from utility after you switch on the input breaker. In Bypass mode, the load is not protected by UPS. To protect your precious devices, you should turn on the UPS. Refer to next step.

- 2) Press and hold the "ON" button for 0.5s to turn on the UPS and the buzzer will beep once.
- 3) A few seconds later, the UPS will enter to AC mode. If the utility power is abnormal, the UPS will operate in Battery mode without interruption.

NOTE: When the UPS is running out battery, it will shut down automatically at Battery mode. When the utility power is restored, the UPS will auto restart in AC mode.

3-4-2. Turn on the UPS without utility power supply (in Battery mode)

- 1) Make sure that the breaker of the battery pack is at "ON" position (only for long-run model).

- 2) Press the "ON" button to set up the power supply for the UPS, UPS will enter to power on mode. After initialization UPS will enter to No Output mode, then Press and hold the "ON" button for 0.5s to turn on the UPS, and the buzzer will beep once.
- 3) A few seconds later, the UPS will be turned on and enter to Battery mode.

3-4-3. Connect devices to UPS

After the UPS is turned on, you can connect devices to the UPS.

- 1) Turn on the UPS first and then switch on the devices one by one, the LCD panel will display total load level.
- 2) If it is necessary to connect the inductive loads such as a printer, the in-rush current should be calculated carefully to see if it meets the capacity of the UPS, because the power consumption of this kind of loads is too big.
- 3) If the UPS is overload, the buzzer will beep twice every second.
- 4) When the UPS is overload, please remove some loads immediately. It is recommended to have the total loads connected to the UPS less than 80% of its nominal power capacity to prevent overload for system safety.
- 5) If the overload time is longer than acceptable time listed in spec at AC mode, the UPS will automatically transfer to Bypass mode. After the overload is removed, it will return to AC mode. If the overload time is longer than acceptable time listed in spec at Battery mode, the UPS will become fault status. At this time, if bypass is enabled and the voltage and frequency in the range of it is set value, the UPS will power to the load via bypass. If bypass function is disabled or the input power is not within bypass acceptable range, it will cut off output directly.

3-4-4. Charge the batteries

- 1) After the UPS is connected to the utility power and working on the AC mode, the charger will charge the batteries automatically except in Battery mode or during battery self-test.
- 2) Suggest to charge batteries at least 10 hours before use. Otherwise, the backup time may be shorter than expected time.
- 3) Make sure the battery numbers setting on the control board (Please refer to the section 3-4-12 for detailed setting) is consistent to real connection.

3-4-5. Battery mode operation

- 1) When the UPS is in Battery mode, the buzzer will beep according to different battery capacity. If the battery capacity is more than 25%, the buzzer will beep once every 4 seconds; If the battery voltage drops to the alarm level, the buzzer will beep quickly (once every sec) to remind users that the battery is at low level and the UPS will shut down automatically soon. Users could switch off some non-critical loads to disable the shutdown alarm and prolong the backup time (**Note: If the UPS is equipped with the programmable output function, the UPS will cut off the programmable output terminal automatically when the programmable timer function is enabled**). If there is no more load to be switched off at that time, you have to shut down all loads as soon as possible to protect the devices or save data. Otherwise, there is a risk of data loss or load failure.
- 2) In Battery mode, if buzzer sound annoys, users can press the Mute button to disable the buzzer.
- 3) The backup time of the long-run model depends on the external battery capacity.
- 4) The backup time may vary from different environment temperature and load type.
- 5) When setting backup time for 16.5 hours (990min in LCD setting menu 09), after discharging 16.5 hours, UPS will shut down automatically to protect the battery. This battery discharge protection

can be enabled or disabled through LCD panel control. (Refer to 3-7 LCD setting section)

3-4-6. Test the batteries

- 1) If you need to check the battery status when the UPS is running in AC mode/CVCF mode/ECO mode, you could press the "Test" button to let the UPS do battery self-test.
- 2) To keep the system reliable, the UPS can perform the battery self-test periodically while connect the monitoring software.
- 3) Users also can set battery self-test through monitoring software.
- 4) If the UPS is at battery self-test, the LCD display and buzzer indication will be the same as at Battery mode except that the battery LED is flashing.

3-4-7. Turn off the UPS with utility power supply in AC mode

- 1) Turn off the inverter of the UPS by pressing "OFF" button for at least 0.5s, and then the buzzer will beep once. The UPS will turn into Bypass mode.

NOTE 1: If the UPS has been set to enable the bypass output, it will bypass voltage from utility power to output terminal even though you have turned off the UPS (inverter).

NOTE 2: After turning off the UPS, please be aware that the UPS is working at Bypass mode and there is risk of power loss for connected devices.

- 2) In Bypass mode, output voltage of the UPS is still present. In order to cut off the output, switch off the input breaker. A few seconds later, there is no display shown on the display panel and UPS is complete off.

3-4-8. Turn off the UPS without utility power supply in Battery mode

- 1) Turn off the UPS by pressing "OFF" button for at least 0.5s, and then the buzzer will beep once.
- 2) Then UPS will cut off power to output and there is no display shown on the display panel.

3-4-9. Mute the buzzer

- 1) To mute the buzzer, please press the "Mute" button for at least 0.5s. If you press it again after the buzzer is muted, the buzzer will beep again.
- 2) Some warning alarms can't be muted unless the error is fixed. Please refer to section 3-3 for the details.

3-4-10. Operation in warning status

- 1) When Fault LED flashes and the buzzer beeps once every second, it means that there are some problems for UPS operation. Users can get the warning code from LCD panel. Please check the 3-11 warning code table and the trouble shooting table in chapter 4 for details.
- 2) Some warning alarms can't be muted unless the error is fixed. Please refer to section 3-3 for the details.

3-4-11. Operation in Fault mode

- 1) When Fault LED illuminates and the buzzer beeps continuously, it means that there is a fatal error in the UPS. Users can get the fault code from display panel. Please check the 3-9 fault code table and the trouble shooting table in chapter 4 for details.
- 2) Please check the loads, wiring, ventilation, utility, battery and so on after the fault occurs. Don't try to turn on the UPS again before solving the problems. If the problems can't be fixed, please contact the distributor or service people immediately.

- 3) For emergency case, please cut off the connection from utility, external battery, and output immediately to avoid more risk or danger.

3-4-12. Operation of changing battery numbers

- 1) This operation is only available for professional or qualified technicians.
- 2) Turn off the UPS. If the load couldn't be cut off, you should remove the cover of maintenance bypass switch on the rear panel and turn the maintenance switch to "BPS" position first.
- 3) Switch off the input breaker, and switch off the battery breaker (only available for long-run model).
- 4) Remove the cabinet cover and disconnect battery wire for standard model. Then, modify the jumper on the control board to set the battery numbers as below table.

Battery Number in series	JP1				
	pin1 & pin2	pin3 & pin4	Pin5 & pin6	pin7 & pin8	Pin9 & pin10
16	X	X	1	0	0
17	X	X	0	1	1
18	X	X	0	1	0
19	X	X	0	0	1
20	X	X	0	0	0

Note: 0 = no jumper; 1 = connect with jumper; x = the pins are for other functions.

- 5) Modify the battery pack to meet the setting number in control board carefully.
- 6) Modify charger voltage according to below table to meet the setting number in control board. There are 5 jumpers on the charger board. Please refer to the below table to modify charger voltage.

Battery Number in series	Charge voltage (V)	JP01	JP02	JP03	JP04	JP05
16	218	0	0	0	1	0
17	232	0	0	1	0	0
18	245	0	1	0	0	0
19	259	1	0	0	0	0
20	273	0	0	0	0	0

Note: 0 = no jumper; 1 = connect with jumper.

- 7) After complete the above steps, put the cover back, switch on the battery breaker for long-run model and switch on the input breaker. Then, the UPS will enter Bypass mode. If the UPS is in maintenance Bypass mode, turn the maintenance switch to "UPS" position and then turn on the UPS.

3-4-13. Operation of changing charging current:

- 1) This operation is only available for professional or qualified technicians.
- 2) Turn off the UPS. If the load couldn't be cut off, you should remove the cover of maintenance bypass switch on the rear panel and turn the maintenance switch to "BPS" position first.
- 3) Switch off the input breaker, and switch off the battery breaker (only available for long-run model).
- 4) Remove the cabinet cover, and disconnect battery wire for standard model. Then modify the jumpers on the charger board to set the charging current (refer to table below). Be careful that the maximum charge current should not exceed the battery accepted charging current.

Charge current (A)	JP06	JP07	JP08
1A	0	0	1
2A	0	1	0
3A	1	0	0
4A	0	0	0

Note: 0 = no jumper; 1 = connect with jumper.

3-5. Parallel Operation

3-5-1. Parallel system initial startup

First of all, please make sure all of the UPSs are parallel models and have the same configuration.

- 1) Turn on each UPS to AC mode respectively (Refer to section 3-4-1). Then, measure the output voltage of each UPS to check if the voltage difference between actual output and setting value is less than 1.5V (typical 1V) with multimeter. If the difference is more than 1.5V, please calibrate the voltage by configuring inverter voltage adjustment (Refer to Program 15, section 3-7) in LCD setting. If voltage difference remains more than 1.5V after calibration, please contact your local distributor or service center for help.
- 2) Calibrate the output voltage measurement by configuring output voltage calibration (Refer to Program 16, section 3-7) in LCD setting to make sure the error between real output voltage and detected value of UPS is less than 1V.
- 3) Turn off each UPS (Refer to section 3-4-7.). Then, follow the wiring procedure in section 2-4.
- 4) Remove the cover of parallel share current cable port on the UPS, connect each UPS one by one with the parallel cable and share current cable, and then screw the cover back.

3-5-2. Turn on the parallel system in AC mode

- 1) Turn on the input breaker of each UPS. After all UPSs enter to bypass mode, measure the voltage between output L1 of each UPS with multimeter. If the voltage difference is less than 1V, that means all connections are correct. Otherwise, please check if the wirings are connected correctly.
- 2) Turn on the output breaker of each UPS. Before turning on each UPS in turns, check if PARXXX is displayed in each UPS sequentially. If no "PARXXX" exists in any UPS, please check if the parallel cables are connected correctly.
- 3) Turn on each UPS in turns. After a while, the UPSs will enter to AC mode synchronously and then, the parallel system is completed.

3-5-3. Turn on the parallel system in Battery mode

- 1) Turn on the battery breaker (only available in long-run model) and output breaker of each UPS.
NOTE: It's not allowed to share one battery pack for long-run UPSs in parallel system. Each UPS should be connected to its battery pack.
- 2) Turn on any UPS. A few seconds later, the UPS will enter to battery mode.
- 3) Press the "ON" button to set up the power supply for another UPS, check if PARXXX is displayed. If not, please check if the parallel cables are connected correctly. Then Turn on another UPS. A few seconds later, the UPS will enter to battery mode and add to the parallel system.
- 4) If you have the third UPS, follow the same procedure of 3). Then, the parallel system is complete.

3-5-4. Add one new unit into the parallel system

- 1) You can not add one new unit into the parallel system when whole system is running. You must cut off the load and shutdown the system.
- 2) Make sure all of the UPS are the parallel models, and follow the wiring refer to section 2-4.
- 3) Install the new parallel system refers to the previous section.

3-5-5. Remove one unit from the parallel system

There are two methods to remove one unit from the parallel system:

First method:

- 1) Press the "OFF" key twice and each time should last for more than 0.5s. Then, the UPS will enter into bypass mode without output.
- 2) Turn off the output breaker of this unit, and then turn off the input breaker of this unit.

- 3) After it shuts down, you can turn off the battery breaker (for long-run model) and remove the parallel cable and share current cable. Then, remove the unit from the parallel system.

Second method:

- 1) If the bypass is abnormal, you can not remove the UPS without interruption. You must cut off the load and shut down the system.
- 2) Make sure the bypass setting is enabled in each UPS and then turn off the running system. All UPSs will transfer to Bypass mode. Remove all the maintenance bypass covers and set the maintenance switches from "UPS" to "BPS". Turn off the input breakers and battery breakers.
- 3) Remove the UPS that you want.
- 4) Turn on the input breaker of the remaining UPSs and the system will transfer to Bypass mode.
- 5) Set the maintenance switches from "BPS" to "UPS" and put the maintenance bypass covers back. Turn on the remaining UPSs and finish the parallel system connection.



Warning: (Only for the parallel system)

- Before turning on the parallel system to activate inverter, make sure that all unit's maintenance switch at the same position.
- When parallel system is turned on to work through inverter, please do not operate the maintenance switch of any unit.

3-6. Abbreviation Meaning in LCD Display

Abbreviation	Display content	Meaning
ENA	ENR	Enable
DIS	diS	Disable
ATO	AtO	Auto
BAT	bAt	Battery
NCF	nCF	Normal mode (not CVCF mode)
CF	CF	CVCF mode
SUB	SuB	Subtract
ADD	AdD	Add
ON	oN	On
OFF	oFF	Off
FBD	Fbd	Not allowed
OPN	oPN	Allow
RES	rES	Reserved
OP.V	oPu	Output voltage
PAR	PaR	Parallel

3-7. LCD Setting

There are three parameters to set up the UPS. Refer to following diagram.

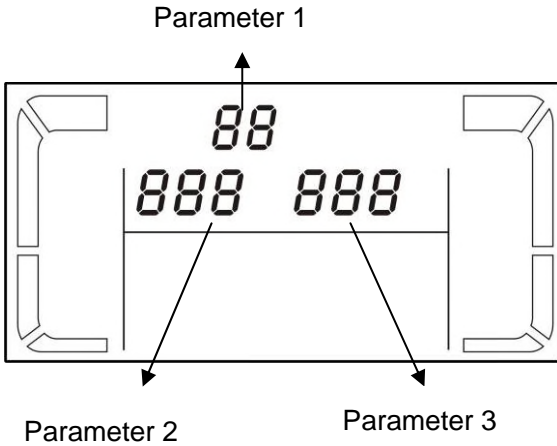

Parameter 1: It's for program alternatives. Refer to below table for the detailed programs.
 Parameter 2 and parameter 3 are the setting options or values for each program.

Programs available list for parameter 1:

Code	Description	Bypass/ No output	AC	ECO	CVCF	Battery	Battery Test
01	Output voltage	Y					
02	Output frequency	Y					
03	Voltage range for bypass	Y					
04	Frequency range for bypass	Y					
05	ECO mode enable/disable	Y					
06	Voltage range for ECO mode	Y					
07	ECO mode frequency range setting	Y					
08	Bypass mode setting	Y	Y				
09	Battery backup time setting	Y	Y	Y	Y	Y	Y
10	Programmable output setting	Y	Y	Y	Y	Y	Y
11	Shutdown point for programmable output	Y	Y	Y	Y	Y	Y
12	Hot standby function enable/disable	Y	Y	Y	Y	Y	Y
13	Battery voltage adjustment	Y	Y	Y	Y	Y	Y
14	Charger voltage adjustment	Y	Y	Y	Y	Y	Y
15	Inverter voltage adjustment		Y		Y	Y	
16	Output voltage calibration		Y		Y	Y	



*Y means that this program can be set in this mode.

Note: All parameter settings will be saved only when UPS shuts down normally with internal or external battery connection. (Normal UPS shutdown means turning off input breaker in bypass mode).

● 01: Output voltage

Interface	Setting
	<p>Parameter 3: Output voltage You may choose the following output voltage in parameter 3: 208: Presents output voltage is 208Vac 220: Presents output voltage is 220Vac 230: Presents output voltage is 230Vac 240: Presents output voltage is 240Vac</p>

● **02: Output frequency**

Interface	Setting
<p style="text-align: center;">60 Hz, CVCF mode</p> 	<p>Parameter 2: Output Frequency Setting the output frequency. You may choose following three options in parameter 2: 50.0Hz: The output frequency is setting for 50.0Hz. 60.0Hz: The output frequency is setting for 60.0Hz. ATO: If selected, output frequency will be decided according to the latest normal utility frequency. If it is from 46Hz to 54Hz, the output frequency will be 50.0Hz. If it is from 56Hz to 64Hz, the output frequency will be 60.0Hz. ATO is default setting.</p>
<p style="text-align: center;">50 Hz, Normal mode</p> 	<p>Parameter 3: Frequency mode Setting output frequency at CVCF mode or not CVCF mode. You may choose following two options in parameter 3: CF: Setting UPS to CVCF mode. If selected, the output frequency will be fixed at 50Hz or 60Hz according to setting in parameter 2. The input frequency could be from 46Hz to 64Hz. NCF: Setting UPS to normal mode (not CVCF mode). If selected, the output frequency will synchronize with the input frequency within 46~54 Hz at 50Hz or within 56~64 Hz at 60Hz according to setting in parameter 2. If 50 Hz selected in parameter 2, UPS will transfer to battery mode when input frequency is not within 46~54 Hz. If 60Hz selected in parameter 2, UPS will transfer to battery mode when input frequency is not within 56~64 Hz.</p>
<p style="text-align: center;">ATO</p> 	<p>*If Parameter 2 is ATO, the Parameter 3 will show the current frequency.</p>

Note: If the UPS is set to CVCF mode, the bypass function will be disabled automatically.

But when a single UPS without parallel function is powered on with mains and before the UPS finished the startup, there will be a few seconds of voltage pulse (same as the input voltage) on the bypass output.

If you need to remove the pulse on this mode to protect your load better, you could contact the dealer for help.

For the UPS with parallel function, this pulse situation won't happen.

● **03: Voltage range for bypass**

Interface	Setting
	<p>Parameter 2: Set the acceptable low voltage for bypass. Setting range is from 110V to 209V and the default value is 110V. Parameter 3: Set the acceptable high voltage for bypass. Setting range is from 231V to 276V and the default value is 264V.</p>

● **04: Frequency range for bypass**

Interface	Setting
	<p>Parameter 2: Set the acceptable low frequency for bypass. 50 Hz system: Setting range is from 46.0Hz to 49.0Hz. 60 Hz system: Setting range is from 56.0Hz to 59.0Hz. The default value is 46.0Hz/56.0Hz. Parameter 3: Set the acceptable high frequency for bypass. 50 Hz: Setting range is from 51.0Hz to 54.0 Hz. 60 Hz: Setting range is from 61.0Hz to 64.0Hz. The default value is 54.0Hz/64.0Hz.</p>

● **05: ECO mode enable/disable**

Interface	Setting
	<p>Parameter 3: Enable or disable ECO function. You may choose following two options: DIS: disable ECO function ENA: enable ECO function If ECO function is disabled, voltage range and frequency range for ECO mode still can be set, but it is meaningless unless the ECO function is enabled.</p>

● **06: Voltage range for ECO mode**

Interface	Setting
	<p>Parameter 2: Low voltage point in ECO mode. The setting range is from 5% to 10% of the nominal voltage. Parameter 3: High voltage point in ECO mode. The setting range is from 5% to 10% of the nominal voltage.</p>

● **07: Frequency range for ECO mode**

Interface	Setting
	<p>Parameter 2: Set low frequency point for ECO mode. 50 Hz system: Setting range is from 46.0Hz to 48.0Hz. 60 Hz system: Setting range is from 56.0Hz to 58.0Hz. The default value is 48.0Hz/58.0Hz. Parameter 3: Set high frequency point for ECO mode. 50 Hz: Setting range is from 52.0Hz to 54.0 Hz. 60 Hz: Setting range is from 62.0Hz to 64.0Hz. The default value is 52.0Hz/62.0Hz.</p>

● **08: Bypass mode setting**

Interface	Setting
	<p>Parameter 2: OPN: Bypass allowed. When selected, UPS will run at Bypass mode depending on bypass enabled/disabled setting. FBD: Bypass not allowed. When selected, it's not allowed for running in Bypass mode under any situations. Parameter 3: ENA: Bypass enabled. When selected, Bypass mode is activated. DIS: Bypass disabled. When selected, automatic bypass is acceptable, but manual bypass is not allowed. Manual bypass means users manually operate UPS for Bypass mode. For example, pressing OFF button in AC mode to turn into Bypass mode.</p>



● **09: Battery backup time setting**

Interface	Setting
	<p>Parameter 3: 000~999: Set the maximum backup time from 0min to 999min. UPS will shut down to protect battery after backup time arrives. DIS: Disable battery discharge protection and backup time will depend on battery capacity. The default value is DIS.</p>

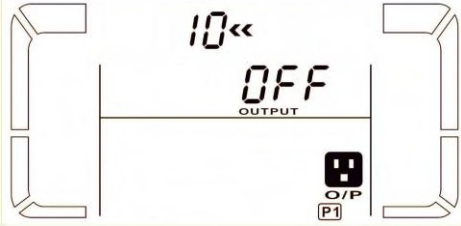
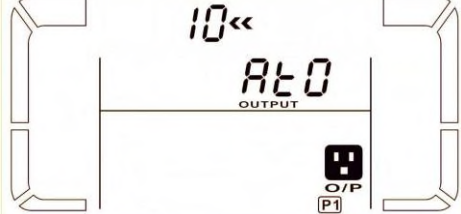
● **10: Programmable output setting (only available for the model with programmable output function)**

Interface	Setting
 <p>10<< OFF OUTPUT</p>	<p>Parameter 3: Set programmable output. You may choose the following three options: ON: Programmable output is manually switched on timelessly. OFF: Programmable output is manually switched off. However, if UPS restarts, this setting will automatically go to "ATO" status. ATO: Programmable output is automatically turned on or cut off according to battery or load status. When the battery voltage is lower than the setting point, or shutdown time arrives, the programmable output will be cut off automatically. After the utility is recovering, the output will turn on automatically. If overload happens, the programmable output also will be cut off automatically. If it happens 3 times, the programmable output will be cut off until it is manually switched on.</p>
 <p>10<< ATO OUTPUT</p>	

● **11: Shutdown point for programmable output (only available for the model with programmable output function)**

Interface	Setting
 <p>11<< 001 038</p>	<p>Parameter 2: 001. Set shutdown time for programmable output. Parameter 3: Shutdown time in minutes. Setting range is from 0 to 300. When shutdown time arrives, the programmable output terminal will be cut off. The default value is 30 minutes.</p>
 <p>11<< 002 11.2^{Vdc}</p>	<p>Parameter 2: 002 Set shutdown voltage for programmable output. Parameter 3: Shutdown voltage in V. Setting range is from 11.2 to 13.6. If the battery voltage is less than the setting point, the programmable output will be cut off. The default value is 11.2V.</p>

● **12: Hot standby function enable/disable**

Interface	Setting
 <p>12<< HSH YES</p>	<p>Parameter 2: HS.H Enable or disable Hot standby function. You may choose following two options in Parameter 3: YES: Hot standby function is enabled. It means that the current UPS is set to host of the hot standby function, and it will restart after AC recovery even without battery connected. NO: Hot standby function is disabled. The UPS is running at normal mode and can't restart without battery</p>

● **13: Battery voltage adjustment**

Interface	Setting
 <p>13<< Add 0.18^{Vdc}</p>	<p>Parameter 2: Select "Add" or "Sub" function to adjust battery voltage to real figure. Parameter 3: the voltage range is from 0V to 5.7V, the default value is 0V.</p>



● **14: Charger voltage adjustment**

Interface	Setting
	<p>Parameter 2: you may choose Add or Sub to adjust charger voltage</p> <p>Parameter 3: the voltage range is from 0V to 9.9V, the default value is 0V.</p> <p>NOTE: *Before making voltage adjustment, be sure to disconnect all batteries first to get the accurate charger voltage. *We strongly suggest to use the default value (0). Any modification should be suitable to battery specifications.</p>

● **15: Inverter voltage adjustment**

Interface	Setting
	<p>Parameter 2: you may choose Add or Sub to adjust inverter voltage</p> <p>Parameter 3: the voltage range is from 0V to 6.4V, the default value is 0V.</p>

● **16: Output voltage calibration**

Interface	Setting
	<p>When the output voltage can not be detected (less than 50VAC), this menu will be reserved, "RES" will be displayed in parameter 2 and parameter 3.</p>
	<p>Parameter 2: it always shows OP.V as output voltage.</p> <p>Parameter 3: it shows the internal measurement value of the output voltage, and you can calibrate it by pressing Up or Down according to the measurement from an external voltage meter. The calibration result will be effective by pressing Enter. The calibration range is limited within +/-9V. This function is normally used for parallel operation.</p>

3-8. Operating Mode/Status Description

If parallel UPS systems are successfully set up, it will show one more screen with "PAR" in parameter 2 and be assigned number in parameter 3 as below parallel screen diagram. The master UPS will be default assigned as "001" and slave UPSs will be assigned as either "002" or "003". The assigned numbers may be changed dynamically in the operation;

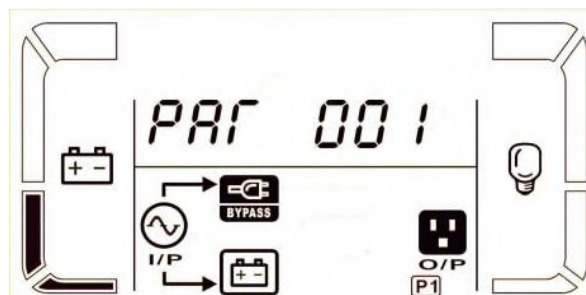

















Operating mode/status		
AC mode	Description	When the input voltage is within acceptable range, UPS will provide pure and stable AC power to output. The UPS will also charge the battery at AC mode.
	LCD display	
ECO mode	Description	When the input voltage is within voltage regulation range and ECO mode is enabled, UPS will bypass voltage to output for energy saving.
	LCD display	
CVCF mode	Description	When input frequency is within 46 to 64Hz, the UPS can be set at a constant output frequency, 50 Hz or 60 Hz. The UPS will still charge battery under this mode.
	LCD display	
Battery mode	Description	When the input voltage is beyond the acceptable range or power failure, UPS will backup power from battery and alarm will beep every 4 seconds.
	LCD display	
Bypass mode	Description	When input voltage is within acceptable range and bypass is enabled, turn off the UPS and it will enter Bypass mode. Alarm beeps every two minutes.
	LCD display	

Battery Test	Description	When UPS is in AC mode or CVCF mode, press "Test" key for more than 0.5s. Then the UPS will beep once and start "Battery Test". The line between I/P and inverter icons will blink to remind users. This operation is used to check the battery status.	
	LCD display		
Fault status	Description	When UPS has fault happened, it will display fault messages in LCD panel.	
	LCD display		

3-9. Fault Code

Fault event	Fault code	Icon	Fault event	Fault code	Icon
Bus start failure	01	None	Battery SCR short circuited	21	None
Bus over	02	None	Inverter relay short circuited	24	None
Bus under	03	None	Charger short circuited	2a	None
Bus unbalance	04	None	Can communication fault	31	None
Inverter soft start failure	11	None	Parallel output current unbalance	36	None
High Inverter voltage	12	None	Over temperature	41	None
Low Inverter voltage	13	None	CPU communication failure	42	None
Inverter output short circuited	14	SHORT	Overload	43	OVER LOAD
Negative power fault	1A	None	Battery turn-on failure	6A	None
Inverter over current	60	None	PFC current failure in battery mode	6B	None
Inverter waveform abnormal	63	None	Bus voltage changes too fast	6C	None

3-10. Warning Indicator





Warning	Icon (flashing)	Alarm
Battery low	 	Beeping every second
Overload	 	Beeping twice every second
Battery unconnected	 	Beeping every second
Over charge	 	Beeping every second
EPO enable	 	Beeping every second
Fan failure/Over temperature	 	Beeping every second
Charger failure	 	Beeping every second
I/P fuse broken	 	Beeping every second
Overload 3 times in 30min		Beeping every second

3-11 Warning Code

Warning code	Warning event	Warning code	Warning event
01	Battery unconnected	10	L1 IP fuse broken
07	Over charge	21	Line situations are different in parallel system
08	Low battery	22	Bypass situations are different in parallel system
09	Overload	33	Locked in bypass after overload 3 times in 30min
0A	Fan failure	3A	Cover of maintain switch is open
0B	EPO enable	3D	Bypass unstable
0D	Over temperature	3E	Boot loader is missing
0E	Charger failure		

4. Trouble Shooting

If the UPS system does not operate correctly, please solve the problem by using the table below.

Symptom	Possible cause	Remedy
No indication and alarm in the front display panel even though the mains is normal.	The AC input power is not connected well.	Check if input cable firmly connected to the mains.
The icon  and the warning code EP flash on LCD display and alarm beeps every second.	EPO function is enabled.	Set the circuit in closed position to disable EPO function.
The icon  and BATT. FAULT flash on LCD display and alarm beeps every second.	The external or internal battery is incorrectly connected.	Check if all batteries are connected well.
The icon  and OVER LOAD flash on LCD display and alarm beeps twice every second.	UPS is overload.	Remove excess loads from UPS output.
	UPS is overloaded. Devices connected to the UPS are fed directly by the electrical network via the Bypass.	Remove excess loads from UPS output.
	After repetitive overloads, the UPS is locked in the Bypass mode. Connected devices are fed directly by the mains.	Remove excess loads from UPS output first. Then shut down the UPS and restart it.
Fault code is shown as 43. The icon OVER LOAD lights on LCD display and alarm beeps continuously.	UPS is overload too long and becomes fault. Then UPS shut down automatically.	Remove excess loads from UPS output and restart it.
Fault code is shown as 14, the icon SHORT lights on LCD display, and alarm beeps continuously.	The UPS shut down automatically because short circuit occurs on the UPS output.	Check output wiring and if connected devices are in short circuit status.
Fault code is shown as 1, 2, 3, 4, 11, 12, 13, 14, 1A, 21, 24, 35, 36, 41, 42 or 43 on LCD display and alarm beeps continuously.	A UPS internal fault has occurred. There are two possible results: 1. The load is still supplied, but directly from AC power via bypass. 2. The load is no longer supplied by power.	Contact your dealer.
Battery backup time is shorter than nominal value	Batteries are not fully charged	Charge the batteries for at least 7 hours and then check capacity. If the problem still persists, consult your dealer.
	Batteries defect	Contact your dealer to replace the battery.
The icon  and  flash on LCD display and alarm beeps every second.	Fan is locked or not working; or the UPS temperature is too high.	Check fans and notify dealer.

5. Storage and Maintenance

5-1. Storage

Before storing, charge the UPS at least 7 hours. Store the UPS covered and upright in a cool, dry location. During storage, recharge the battery in accordance with the following table:

Storage Temperature	Recharge Frequency	Charging Duration
-25°C - 40°C	Every 3 months	1-2 hours
40°C - 45°C	Every 2 months	1-2 hours

5-2. Maintenance



The UPS system operates with hazardous voltages. Repairs may be carried out only by qualified maintenance personnel.



Even after the unit is disconnected from the mains, components inside the UPS system are still connected to the battery packs which are potentially dangerous.



Before carrying out any kind of service and/or maintenance, disconnect the batteries and verify that no current is present and no hazardous voltage exists in the terminals of high capability capacitor such as BUS-capacitors.



Only persons are adequately familiar with batteries and with the required precautionary measures may replace batteries and supervise operations. Unauthorized persons must be kept well away from the batteries.



Verify that no voltage between the battery terminals and the ground is present before maintenance or repair. In this product, the battery circuit is not isolated from the input voltage. Hazardous voltages may occur between the battery terminals and the ground.



Batteries may cause electric shock and have a high short-circuit current. Please remove all wristwatches, rings and other metal personal objects before maintenance or repair, and only use tools with insulated grips and handles for maintaining or repairing.



When replace the batteries, install the same number and same type of batteries.



Do not attempt to dispose of batteries by burning them. This could cause battery explosion. The batteries must be rightly deposited according to local regulation.



Do not open or destroy batteries. Escaping electrolyte can cause injury to the skin and eyes. It may be toxic.



Please replace the fuse only with the same type and amperage in order to avoid fire hazards.



Do not disassemble the UPS system.

6. Specifications

MODEL		6K	6K-S	10K	10K-S
CAPACITY*		6000 VA / 6000 W		10000 VA / 10000 W	
INPUT					
Voltage Range	Line Loss	110~300Vac @ (0~60%) Load 140~300V @ (60~80%) Load 176~300Vac @(80~100%)Load			
	Low Line Comeback	Low Line Loss Voltage + 10V			
	High Line Comeback	High Line Loss Voltage - 10V			
Frequency Range		46Hz ~ 54 Hz @ 50Hz system 56Hz ~ 64 Hz @ 60Hz system			
Phase		Single phase with ground			
Power Factor		≥ 0.99 at 100% Load			
OUTPUT					
Output voltage		208/220/230/240VAC			
AC Voltage Regulation		± 1%			
Frequency Range (Synchronized Range)		46Hz ~ 54 Hz @ 50Hz system 56Hz ~ 64 Hz @ 60Hz system			
Frequency Range (Batt. Mode)		50 Hz ± 0.1 Hz or 60Hz ± 0.1 Hz			
Overload	AC mode	100%~110%: 10min ; 110%~130%: 1min ; >130% : 1sec			
	Battery mode	100%~110%: 30sec ; 110%~130%: 10sec ; >130% : 1sec			
Current Crest Ratio		3:1 max			
Harmonic Distortion		≤ 1 % @ 100% Linear Load; ≤ 4 % @ 100% Non-linear Load			
Transfer Time	Line←→Battery	0 ms			
	Inverter←→Bypass	0 ms			
	Inverter←→ECO	<10 ms			
EFFICIENCY					
AC mode		> 94%			
Battery Mode		> 93%			
BATTERY					
Type	12 V / 7 Ah	Depending on applications	12 V / 9 Ah	Depending on applications	
Numbers	20	16~20**	20	16~20**	
Recharge Time	7 hours recover to 90% capacity	According to external battery pack	9 hours recover to 90% capacity	According to external battery pack	
Charging Current	4 A ± 10% (max.)		4 A ± 10% (max.)		
Charging Voltage	(Battery number x 13.65 V) ± 1%				
PHYSICAL					
Dimension, DXWXH(mm)	592 X 250 X 576	592 X 250 X 576	592 X 250 X 576	592 X 250 X 576	
Net Weight (kgs)	81	25	83	27	
ENVIRONMENT					
Operation Temperature	0 ~ 40°C (the battery life will down when > 25°C)				
Operation Humidity	<95 % and non-condensing				
Operation Altitude**	<1000m				
Acoustic Noise Level	Less than 55dB @ 1 Meter		Less than 58dB @ 1 Meter		
MANAGEMENT					
Smart RS-232 or USB	Supports Windows® 2000/2003/XP/Vista/2008/7/8, Linux and MAC				
Optional SNMP	Power management from SNMP manager and web browser				

* Derate capacity to 60% of capacity in CVCF mode and to 90% when the output voltage is adjusted to 208VAC.

**When using batteries from 16-19, the unit will de-rate according to below formula: P=Prating x N/20

***If the UPS is installed or used in a place where the altitude is above than 1000m, the output power must be derated one percent per 100m.

Product specifications are subject to change without further notice.